



CLEANOUTS

Shape - The first step is to select a top which is compatible with the surrounding area. The exposed tops of floor-level cleanouts are considered as pieces of architectural trim. All Wade tops are carefully engineered for easy, fast and safe cover removal for quick access to the closure plug. *Cleanout tops should be of the correct shape to blend with the surrounding floor and wall area.*

A round top (Fig. 1) is easiest to orient in most floors since it will not conflict with most floor designs or require alignment to adjacent walls. The square nickel bronze top (Fig. 2) is particularly adaptable to floors that are finished with materials of a square or straight line pattern.

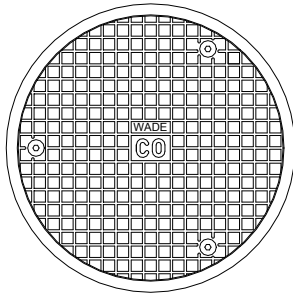

Fig. 1

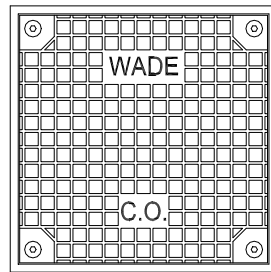

Fig. 2

Style - All areas or rooms which have finished decorative floors will require *finished floor cleanouts*. Examples are offices, hospitals, banks, showrooms and many modern manufacturing areas.

A regular secured *nickel bronze* scoriated top (Fig. 1 or Fig. 2) is recommended for most finished floor areas. Nickel bronze non-skid tops blend with most finished floors.

Suffix -T, -U, -TS or -US In floors where a minimum amount of metal is desired to be shown, cleanout tops are available with a recess to receive the floor materials. Tops are available with a shallow depression to receive vinyl or similar types of floor tile (Fig. 3) or with a deeper design to receive terrazzo or ceramic tile fill (Fig. 4). Square patterns are also available (Fig. 5 or Fig. 6).

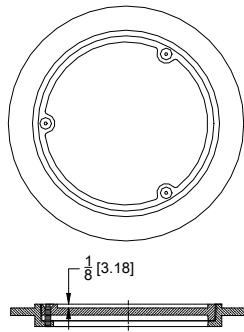

Fig. 3

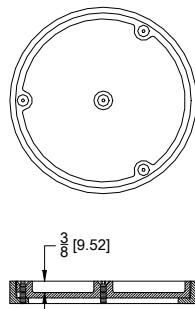

Fig. 4

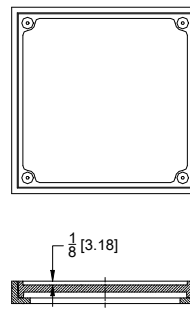

Fig. 5

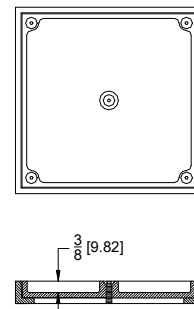

Fig. 6



Carpeted Areas

Cleanouts in areas requiring carpet floors require special consideration. Wade offers two styles of floor cleanouts for these unique situations:

Suffix -CF Carpet Flange (Fig. 7). Adjustable cleanout assembly is installed with cast iron frame flush with concrete slab. Carpet is cut to fit around lower cleanout frame. Carpet is clamped against slab with "Carpet Clamping Flange." Cover is then installed.

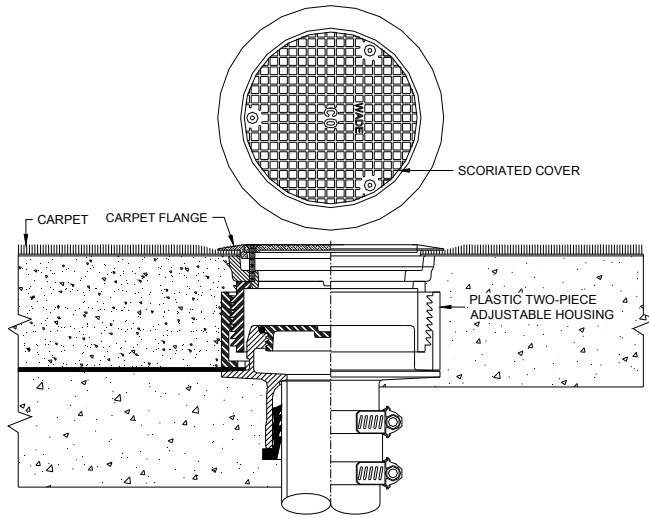

Fig. 7

Suffix -CM Carpet Marker (Fig. 8) - Used with 6000 and 8000 series cleanouts, 1 1/4" diameter marker serves as cleanout locator in carpeted floors. When access to drain line is required, carpet over the cleanout is cut for accessibility to closure plug. After drain line is cleaned, carpet is replaced and marker reinstalled.

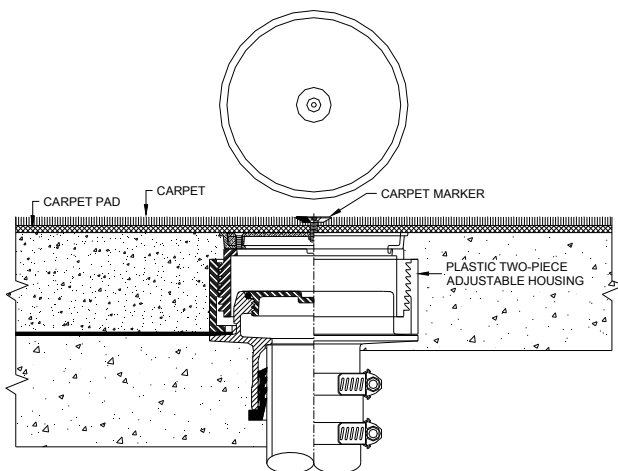

Fig. 8



Traffic Function - Most floors are considered finished floors and nickel bronze tops are recommended; however, there are some areas such as boiler rooms, warehouses and heavy manufacturing areas which may use heavy duty, cast iron tops. In these areas, strength and utility are of prime importance and appearance is a secondary consideration. For unfinished floors, subject to heavy vehicular traffic, round, heavy duty ductile iron tops should be specified (Fig. 9). The Wade special duty design has non-tilt tractor-type covers. The tractor-type cover cannot be tilted out of the cleanout top due to heavy vehicular traffic moving over it. For finished floors, where heavy traffic is anticipated, such as equipment showrooms, convention areas, etc., Wade offers heavy duty ductile iron covers with nickel bronze veneers (Fig. 10).

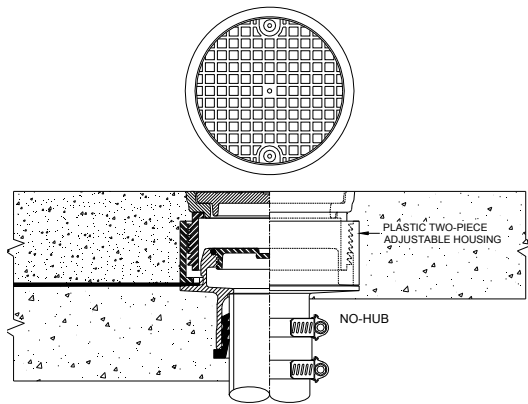

Fig. 9

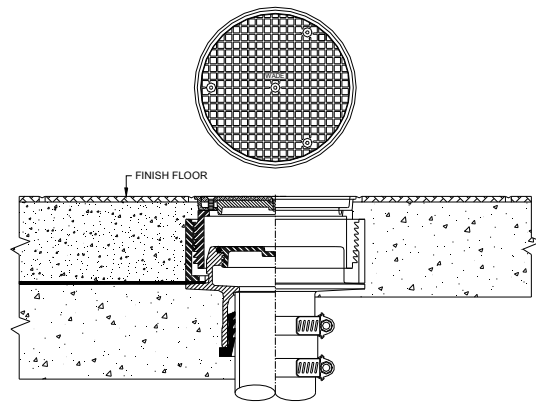

Fig. 10

Asphalt Paved Areas – These applications require special consideration. The top specified must be strong enough to safely carry the loads of anticipated traffic. Also, provision must be made for adequate support. Wade recommends the cleanout be installed into a reinforced concrete pad of sufficient thickness for the anticipated wheel load (Fig. 11). The pad must extend from the center of the cleanout a minimum of 12". This method is to keep weight from transferring to the connected piping. Wade cleanouts 6000-Z, 8000-Z, 8200-Z or 8300-MF are the preferred choice.

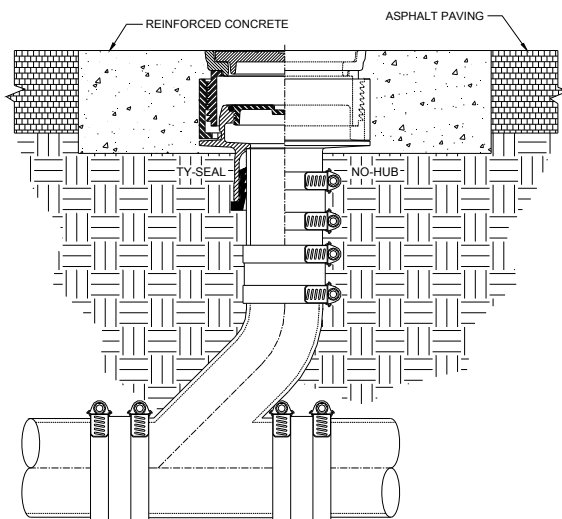

Fig. 11



Material - For most finished floors, the Wade scoriated non-skid nickel bronze tops are recommended. Nickel bronze has excellent corrosion resistant qualities, is extremely serviceable, will not discolor and has an attractive satin finish surface. Nickel bronze tops will not rust stain the surrounding finished floor area as cast iron tops sometimes do. The "scuffing" action of foot traffic on a nickel bronze top will actually add to its appearance, giving it a soft silvery patina. Tops are available in special polished finishes, for use where tops must blend with other architectural trim. For superior corrosion resistance Wade offers type 304 stainless steel tops in both square and round.

Body Selection

Outlet Type - Bodies which are used with adjustable floor-level cleanout assemblies are available with three types of outlet connections, No-Hub and Ty-Seal (Push-On) and Inside Caulk which can be effectively used, depending on the type of connection desired for piping used in the system and compliance with plumbing code stipulations.

"NO HUB" outlet bodies (Fig. 12) are used for cast iron soil pipe and fittings manufactured to standards CISPI 301 and/or ASTM A888. A Tyler or Anaco/Husky coupling is used to make the joint. The joint consist of a neoprene sleeve and a stainless steel shield with band clamps. The stainless steel shield slides over the pipe. The rubber sleeve slips over the spigot end of a pipe, the cleanout ferrule outlet slips into the adjoining end. The shield positions over the rubber sleeve and is secured with a torque wrench to 60 in.lbs.

Inside caulk outlet bodies (Fig. 13) are desirable when outside access to the joint is cramped or inaccessible or where local codes dictate. The inside caulk body also permits the use of bald end soil pipe pieces, thus effectively using random lengths of soil pipe without hub. Another advantage is that during the rough-in stage, odd lengths can be run up above the cut-off length and left until later. When elevation is finally established, these can then be snap-cut and the cleanout body caulked in place.

"Ty-Seal" cleanouts (Fig. 14) are the easiest type to install. The "Ty-Seal" Neoprene Gasket, will slide over a NO-HUB, Service Weight or Extra Heavy bald end soil pipe stub. Schedule 40 PVC or ABS plastic pipe can be accommodated with standard Ty-Seal push-on outlets in 2", 3" and 4". A special gasket is available for 6" PVC/ABS/XH. The gasket is pre-installed into the cleanout ferrule. Lubricate the gasket with either Tyler Ty-Seal or Lubri-fast lubricant. Align the hub over the spigot end and firmly push down until it contacts the pipe stop in the ferrule.

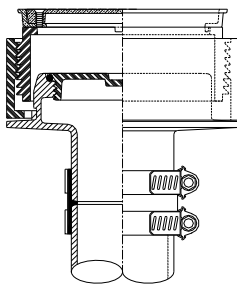

Fig. 12

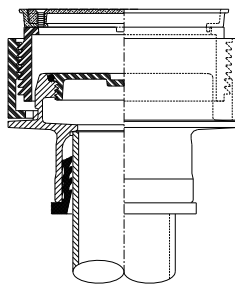

Fig. 13

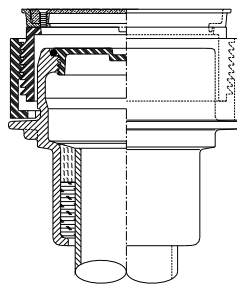

Fig.14



Body Type - Occasionally cleanouts must be installed in areas where a continuous waterproof membrane is used. Many variations of Wade Adjustable Floor-Level Cleanouts are furnished with an integrally cast flange. A flashing clamp (Fig. 15) secures the membrane. It must be noted that seepage control cannot be provided since cleanouts must be gas tight units. A flange is also desirable as it rigidly anchors the cleanout body in concrete.

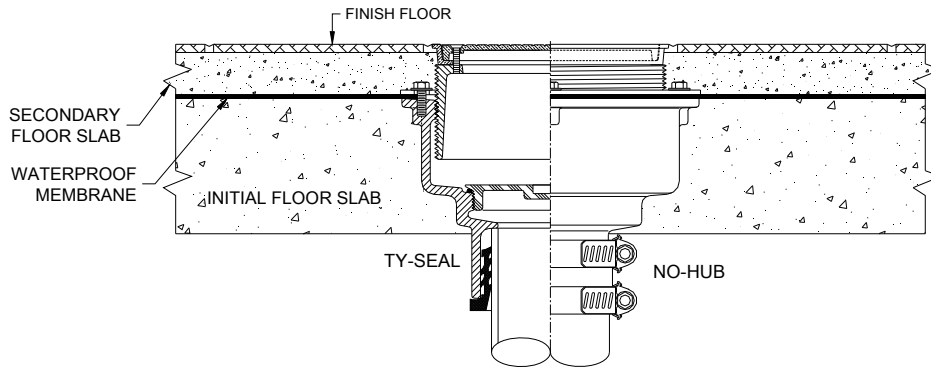

Fig. 15